

# Mr. Straight F

Stehleuchte / floor lamp / lampadaire / lampada da terra



Bernd Unrecht | lights

Typ / type: Mr. Straight - F - C - xx - PSD

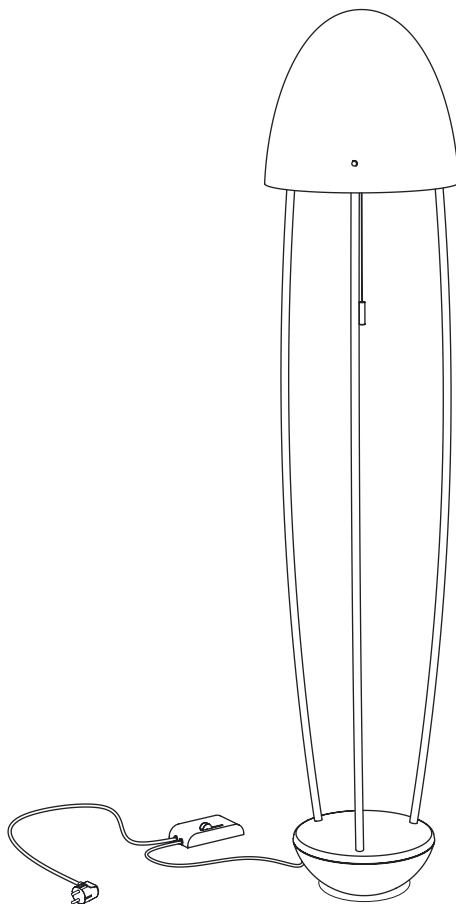

MR.STR - F - C - xx - PSD - 0112

**Montage- und Bedienungsanleitung**  
**Assembly Instructions**  
**Instructions de montage et d'utilisation**  
**Installazione ed istruzioni per l'uso**

Sicherheits- und Installationshinweise

**wichtig !** Vor Gebrauch des Gerätes **bitte die Bedienungsanleitung lesen!** Sie enthält wichtige Hinweise zur Inbetriebnahme und Handhabung des Gerätes. Heben Sie die beigelegte Bedienungsanleitung stets zum Nachlesen auf! Sie muss bei Weitergabe an dritte Personen mit ausgehändig werden.

Technische Daten



**Eingangsspannung 230 V / 50 Hz**



**Leuchtmittel: Fassung: 1 x E27**

- Halogen- Glühlampe, dimmbar  
min. 1 x 60 Watt, max. 1x 105 Watt



dim



- stufenlos dimmbare Energiesparlampe  
max. 1 x 24 Watt



- LED-Retrofit-Lampe oder LED-filament-Lampe: ~ 600 - 1300 lumen



**wichtig !** Bei Leuchten, die mit einem Dimmer ausgestattet sind, dürfen **keine normalen** Energiesparlampen verwendet werden.

Keine Leuchtmittel mit höherer Stärke oder anderen Typs verwenden, als in den Anweisungen und Beschriftungen auf dem Gerät selber angegeben.



Wechsel des Leuchtmittels, Montage oder Wartungsarbeiten



Beim Wechsel des Leuchtmittels, Montage oder Wartungsarbeiten immer Stromzufuhr durch Ausziehen des Steckers aus der Steckdose unterbrechen.

Beim Wechsel des Leuchtmittels das Leuchtmittel immer abkühlen lassen, da sonst **Verbrennungsgefahr besteht !**

**Wenn die Leuchte in Betrieb ist, besteht beim Berühren des Leuchtmittels Verbrennungsgefahr !**

Sicherheits- und Warnhinweise



Reparaturarbeiten dürfen nur von autorisiertem Fachpersonal oder dem Hersteller durchgeführt werden.

Lassen Sie die Verpackungsgegenstände (**Plastikbeutel**, Styropor, Nägel, etc.) nicht in der Reichweite von Kindern, da sie eine Gefahrenquelle darstellen, z.B. **Erstickenungsgefahr !**

Der Apparat darf auf keinen Fall verändert oder unerlaubt geöffnet werden, jede Veränderung desselben kann die Sicherheit in Frage stellen und somit gefährlich werden. Bernd Unrecht lights lehnt jede Verantwortung für unsachgemäß behandelte Produkte ab.

Falls das äußere biegsame Kabel oder das Anschlusskabel dieser Leuchte beschädigt wird, darf es nur vom Hersteller, dessen Servicevertreter oder einer anderen qualifizierten Kraft ausgetauscht werden, um evtl. Risiken zu vermeiden.

Im Falle eines Defekts und/oder bei fehlerhaftem Funktionieren schalten Sie das Gerät aus und verändern Sie nichts. Für eine eventuelle Reparatur innerhalb der Garantiezeit wenden Sie sich ausschließlich an die Verkaufsstelle, wo der Kauf getätigt wurde.

Pflege / Wartung



Vor der Reinigung: Netzstecker ziehen. Bitte die Leuchte ausschließlich mit einem trockenen und weichen Tuch reinigen. Das Reinigen muß in abgekühltem Zustand erfolgen. Verwenden Sie bitte keine lösungsmittelhaltigen Reinigungsmittel!

Allgemeine Hinweise



Nur für die Verwendung in trockenen Räumen.



Montage auf normal entflammaren Flächen zulässig.



Konformität gemäß EU-Richtlinien: EN 60598-1; EN 60598-2-4; 2002/95/EG; 2002/96/EG



Schutzklasse I

Entsorgungshinweis



Altgeräte, die mit dem abgebildeten Symbol gekennzeichnet sind, dürfen nicht mit dem Hausmüll entsorgt werden. Sie müssen sie bei einer Sammelstelle für Altgeräte bei Ihrem Händler, bei dem Sie sie gekauft haben, abgeben. Diese sorgen für eine umweltfreundliche Entsorgung.

Safety and Installation Informations

**important !** Ensure you **read the operating instructions before using the device!** It provides important advice concerning start-up procedures and the operation of the device. Always retain the enclosed operating instruction for reference! The operating instruction must accompany the device if it is passed on to a third party.

Technical data



Input voltage 230 V / 50 Hz



lighting elements: socket: 1 x E27

- halogen- lamp  
min. 1 x 60 Watt, max. 1 x 105 Watt



- **stepless dimmable** energy saving lightbulb  
max. 1 x 24 Watt.



- LED-retrofit-lightbulb or LED-filament-lamp: ~ 600 - 1300 lumen



**important !** Do not use regular energy saving bulbs for lights, which are equipped with a dimmer.

Do not use bulbs of higher power than the one specified in the instructions and on the labels stuck on the light fitting.



Bulb Replacement, Mounting or Maintenance



**When changing the bulbs, executing an assembly or maintenance works always disconnect the power supply by unplugging the power supply cable.**

When changing the bulbs, **allow the lamp to cool down**, otherwise you are in **danger of getting burned !**

**When switched on, the lamp may cause burns when touched !**

Security Advices and Warnings



Repairs may only be performed by an authorised dealer or the manufacturer.

All packaging materials (**plastic bags**, polystyrene, nails etc.) must keep out of reach of children as considered **hazardous and dangerous**.

The appliance may in no way be modified or tampered with, any modification may compromise safety causing the appliance to become dangerous. Bernd Unrecht lights declines all responsibility for products that are modified.

If the external flexible cable or cord of this luminaire is damaged, it shall be exclusively replaced by the manufacturer or his service agent or a similar qualified person in order to avoid a hazard.

In the event of a fault or failure in the appliance, immediately turn it off and do not try and repair it. For repairs covered by the guarantee, contact the retailer where you purchased the appliance.

Cleaning instructions / Maintenance



Cleaning: Before cleaning: Disconnect the power supply. Please clean the lamp with a dry cloth only. Cleaning must only be carried out when the lamp is cool. Please do not use cleaning materials containing solvents.

General Informations



The lamp is for domestic interior use only.



Suitability for direct mounting on normal flammable surfaces.



Conformity according to European Standard Guidelines:  
EN 60598-1; EN 60598-2-4; 2002/95/EC; 2002/96/EC



Safety class I

Notes on Disposal



Old units, marked with the symbol as illustrated, may not be disposed of in the household rubbish. You must take them to a collection point for old units or the dealer from whom you bought them. These agencies will ensure environmentally friendly disposal.

## Remarques Relatives à la Sécurité et l'Installation

**important !** Lire le mode d'emploi avant d'utiliser l'appareil !  
Il contient des indications importantes relatives à la mise en marche et à la manipulation de l'appareil. Conserver le mode d'emploi pour pouvoir le consulter ultérieurement ! Il doit être transmis lors de la cession de l'appareil à un tiers.

## Données techniques



Tension d'entrée 230 V / 50 Hz



**agent lumineux: douille: 1 x E27**

- ampoule alogène, temporisable  
min. 1 x 60 Watt, max. 1 x 105 Watt



- ampoules économiques,  
**temporisable en continu**, max. 1 x 24 Watt



- LED-retrofit-ampoule ou LED-filament-ampoule: ~ 600 - 1300 lumen



**important !** Ne pas utiliser d'ampoules à économie d'énergie normales avec les lampes qui sont déjà équipées d'un variateur.

Ne montez pas d'ampoules de puissances supérieures ou de types différents par rapport à ce qui est indiqué dans les instructions de montage et sur les étiquettes portées sur l'appareil même.



## Remplacement de l'ampoule, montage ou maintenance



Lors de montage, de travaux de maintenance ou de remplacements de sources lumineuses, veillez à toujours interrompre l'alimentation en retirant la fiche de la prise de courant !

Le remplacement de sources lumineuses recèle un risque de brûlures! Laissez refroidir le luminaire avant de le toucher.

Lorsque la lampe est allumée, vous pouvez vous brûler avec l'ampoule !

## Avertissement et Instructions de Sécurité



Les réparations doivent uniquement être effectués par un spécialiste autorisé ou par le fabricant.

Tous les éléments qui forment l'emballage (**emballage en plastique**, polystyrène expansé, clous, etc.) doivent être tenus hors de la portée des enfants, car ils représentent une **source potentielle de danger**.

L'appareil ne peut être modifié ou altéré de quelque manière que ce soit, toute modification peut compromettre la sécurité de celui-ci en le rendant dangereux. Bernd Unrecht lights décline toute responsabilité pour les produits modifiés.

Si le câble électrique flexible ou le cordon d'alimentation de ce luminaire est endommagé, il peut être remplacé. Le remplacement doit impérativement être effectué par le fabricant, un représentant de celui-ci ou un réparateur agréé.

En cas de panne et/ou de dysfonctionnement, éteindre l'appareil et ne pas le manipuler. Pour une éventuelle réparation sous garantie, s'adresser à votre revendeur.

## Nettoyage / Maintenance



- Sortez la fiche mâle de la prise de courant avant tout nettoyage. Pour des raisons de sécurité électrique l'appareil doit être nettoyé avec un chiffon sec. Prière de ne pas utiliser un produit nettoyant à base de dissolvant.

## Notices Explicatives



L'appareil a été conçu pour être utilisé à l'intérieur.



Lampe appropriée pour montage sur des surfaces normalement inflammables.



Conformité technique selon les directives EN:  
EN 60598-1; EN 60598-2-4; 2002/95/EC; 2002/96/EC



- Degré de protection: Classe I

## Conseils pour l'élimination



- Les vieux appareils marqués du symbole représenté sur la figure ne doivent pas être éliminés avec les ordures ménagères. Vous devez les apporter à un point de collecte pour vieux appareils ou les rapporter chez le commerçant où vous les avez achetés. De cette manière, ils seront éliminés en respectant l'environnement.

- Sous réserves d'erreurs d'impression et de modifications techniques.

## Sicurezza e Avvertenze per l'Installazione

**importante !** Leggere le istruzioni per l'uso prima di utilizzare l'apparecchio! Esse contengono informazioni importanti per la messa in funzione e l'impiego dell'apparecchio. Tenerle sempre a disposizione per riferimento futuro! In caso di cessione dell'apparecchio, le istruzioni per l'uso dovranno essere consegnate al nuovo proprietario.

## Dati tecnici



Tensione di alimentazione 230 V / 50 Hz



**Lampadina: portalampada: 1 x E27**  
- lampadina alogena, dimmerabile  
min. 1 x 60 Watt, mass. 1 x 105 Watt



- lampada a risparmio energetico,  
**dimmerabile senza gradini**, mass. 1 x 24 Watt



- LED-retrofit-lampada o LED-filament-lampada: ~ 600 - 1300 lumen



**importante !** dalle lampade, chi funziona con regolatore elettrico, non si deve utilizzare delle lampade a risparmio energetico normale.

Non montare lampadine di potenza superiore o diverso tipo da quelle indicate nelle istruzioni di montaggio e sulle etichette apposte sull'apparecchio stesso.



## Sostituzione della lampadina, montaggio o manutenzione



In caso di sostituzione dei corpi luminosi, di interventi di installazione e di manutenzione interrompere sempre l'alimentazione elettrica eliminando la protezione prevista.

Durante la **sostituzione dei corpi luminosi** sussiste il **pericolo di combustione!** Fare raffreddare la lampada prima di toccarla.

**Pericolo di scottature ! Non toccare la lampadina quando la lampada è accesa!**

## Avviso di sicurezza / Avvertimento



Le riparazioni possono essere effettuate esclusivamente da un esperto autorizzato o dal costruttore.

Gli elementi dell'imballaggio (**sacchetti in plastica**, polistirolo espanso, chiodi ecc.) non devono essere lasciati alla portata dei bambini in quanto **potenziali fonti di pericolo**.

L'apparecchio non può essere in alcun modo modificato o manomesso, ogni modifica ne può compromettere la sicurezza rendendo lo stesso pericoloso. Bernd Unrecht lights declina ogni responsabilità per i prodotti modificati.

Se il cavo flessibile esterno o il filo elettrico di questo prodotto si danneggiano, per motivi di sicurezza devono essere sostituiti esclusivamente dal produttore o da un centro di assistenza autorizzato, oppure da un elettricista qualificato.

In caso di guasto e/o di cattivo funzionamento dell'apparecchio, spegnerlo e non manometterlo. Per l'eventuale riparazione in garanzia rivolgersi solamente al punto vendita dove è stato fatto l'acquisto.

## Pulitura / Manutenzione



Estrarre la spina di rete prima della pulitura. Per motivi di sicurezza elettrica, pulire l'apparecchio con un panno asciutto. Per pulire la lampada non impiegare detergenti contenenti solventi.

## Informazioni Generali



La lampada è stata concepita solo per uso interno.



La lampada può essere installata su superfici ad infiammabilità normale.



Conformità tecnica secondo le Direttive EN:  
EN 60598-1; EN 60598-2-4; 2002/95/EC; 2002/96/EC



Classe di protezione I

## Avvertenze per lo Smaltimento



Le apparecchiature usate, contrassegnate dal simbolo illustrato, non devono essere smaltite tra i rifiuti domestici. Devono essere portate presso un centro di raccolta per apparecchiature usate oppure presso il rivenditore dal quale sono state acquistate. Presso questi centri è possibile lo smaltimento ecologico.

① Montage  
/ assembly  
/ montage  
/ installazione

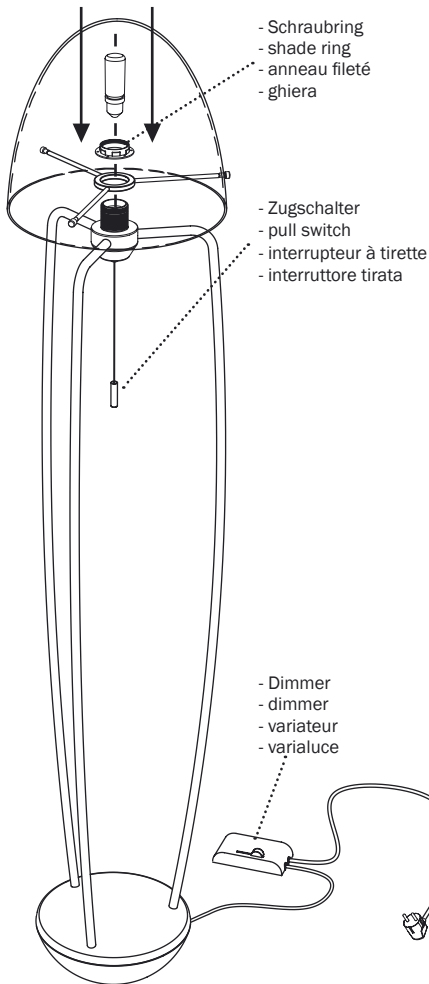
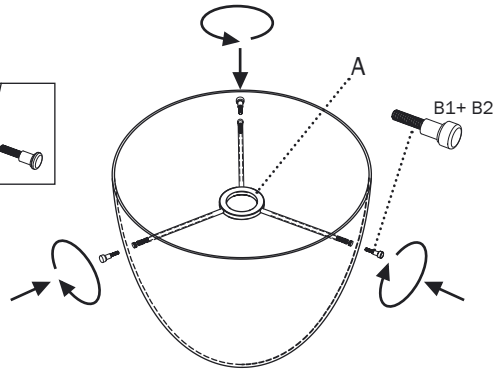
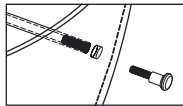
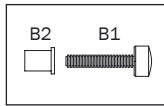

**Montage:**

- 1. Glasschirm auf einen weichen Untergrund stellen (z.B. Kopfkissen). Mit einer Hand die Schirmhalterung (A) festhalten und **vorsichtig** die beiliegenden Schrauben (B1) zusammen mit den Gummihülsen (B2) in die Schirmhalterung (A) einschrauben, wie in Abbildung 1. ACHTUNG: Schrauben dabei nicht zu fest anziehen!
- 2. Den Glasschirm vorsichtig aufsetzen und mit dem Schraubring fixieren (Abbildung 2). Anschließend passendes Leuchtmittel in die Fassung einschrauben.

**assembly:**

- 1. Place the glass shade onto a soft ground (e.g. pillow). Hold the support (A) with one hand and screw carefully the supplied screws (B1) together with the bushings (B2) into the support (A), like in illustration 1 shown. CAUTION: Don't tighten the screws too firmly!
- 2. Set up the glass shade very carefully and fix it with the shade ring (illustration 2). Subsequently screw the suitable bulb into the socket.

- ② Wechseln des Leuchtmittels  
 / Insert bulbs  
 / Changement de l'ampoule  
 / Sostituzione della lampadina

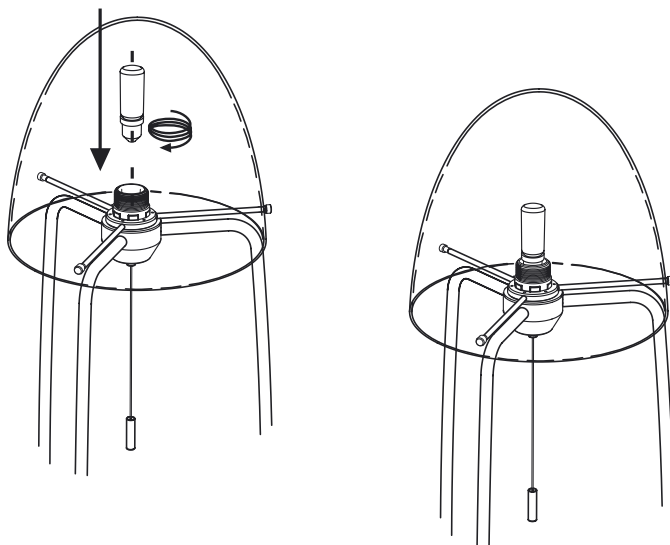

**! Niemals Leuchte kippen und zurückfallen lassen !  
 ! Never tilt the light and drop it back !**

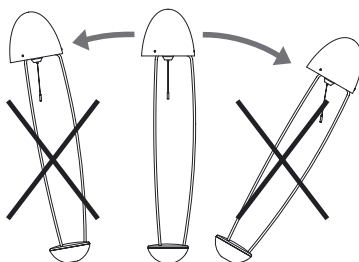

**Dimmen / Schalten:**

- Ein-/ Ausschalten: durch Zugschalter
- Dimmen: durch Bewegen des Schiebereglers am Fußdimmer

**dimming / switching:**

- on/ off: by pull switcher
- dimming: use slider of the floor dimmer

**Regolare / accendere e spengere:**

- Acceso/ Spento: per interruttore tirata
- regolazione: sul cursore di variatore da pavimento

**intensité de lumière / mise en marche:**

- marche/ arrêt: par interrupteur à tirette
- Contrôle lumière: utiliser le curseur de variateur électronique de pied.

Wir wünschen Ihnen viel Freude mit Ihrer Leuchte.  
/ We wish you great pleasure with your lamp.  
/ Nous vous souhaitons beaucoup de plaisir avec votre nouvelle lampe.  
/ Vi auguriamo di trascorrere molte ore liete illuminati dalla luce della Vostra lampada.

---

**Bernd Unrecht lights GmbH**  
Steingadenerstr. 18  
81547 München  
Deutschland

[www.bernd-unrecht-lights.de](http://www.bernd-unrecht-lights.de)  
[info@bernd-unrecht-lights.de](mailto:info@bernd-unrecht-lights.de)

---